



CMD11504 Series Right Angle Surface Mount LED



CMD11504 Series Bright Angle™ Right Angle Surface Mount LED in 3 colors or 1 bicolor

Key Features

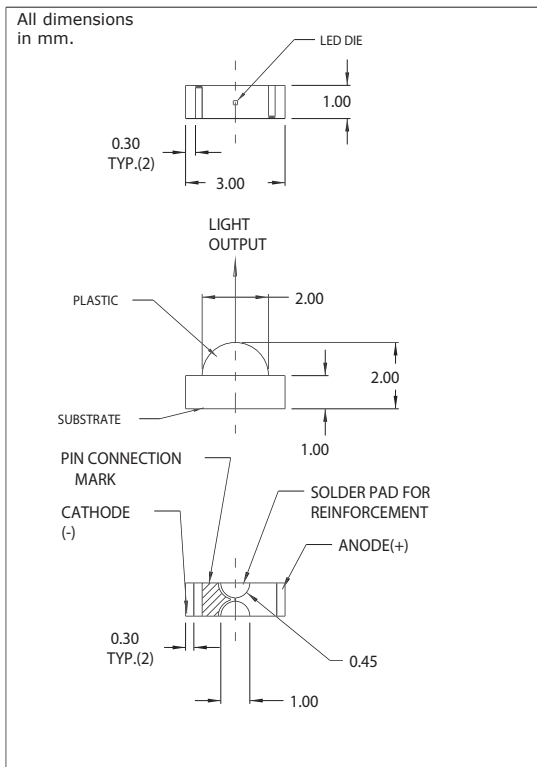

- Right angle mounting.
- Compact size: 3.00mm x 1.00mm x 2.00mm
- High brightness
- The distance between pads of different LEDs shall not be less than 0.10"

Surface Mount Technology

- Tape and reel packaged for high-speed autoinsertion.
- Convection and vapor-phase reflow compatible.
- Compact form enables high density placement.
- Packaged 3000 pieces per reel.
- REACH and RoHS Compliant

Leading Edge LED Optoelectronic Performance

- Consistent high brightness.

Exceptional Reliability

- Stringent process controls assure quality.
- Extensive qualification testing to meet strictest requirements.
- Designed to permit easy post-reflow solder joint inspection.

Electro-Optical Characteristics and Ratings

Part Number	Color	Lens Color	Luminous Intensity @ 20mA		Forward Voltage		Viewing Angle (deg.)	Peak Wavelength (nm)
			Min. (mcd)	Typ. (mcd)	Typ. (V)	Max. (V)		
CMD11504UR	Red	Water Clear	6.2	12.4	1.7	2.3	130	660
CMD11504G	Green	Water Clear	2.6	5.2	2.1	2.8	130	560
CMD11504Y	Yellow	Water Clear	1.5	3.0	2.1	2.8	136	580
CMD11504R/G	Red/Green	Water Clear	6.2/12.4	8.8/17.6	1.7/2.1	2.3/2.8	148/149	572/647

Product Specifications - CMD11504UR (Red)

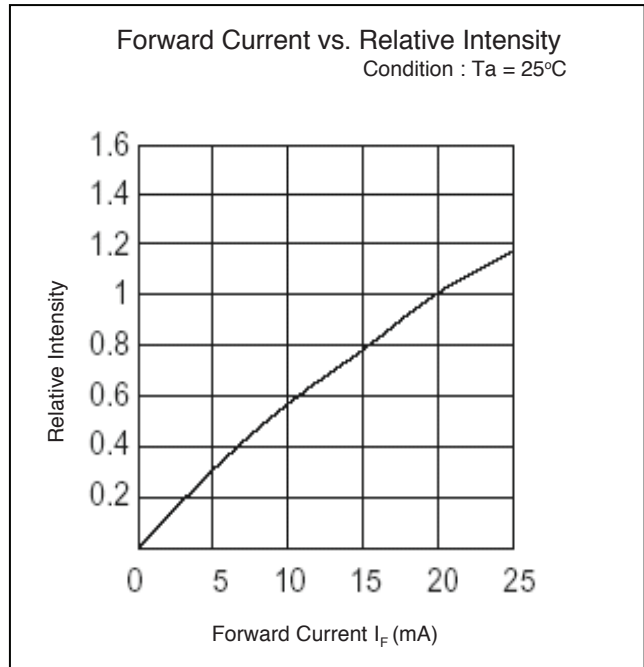
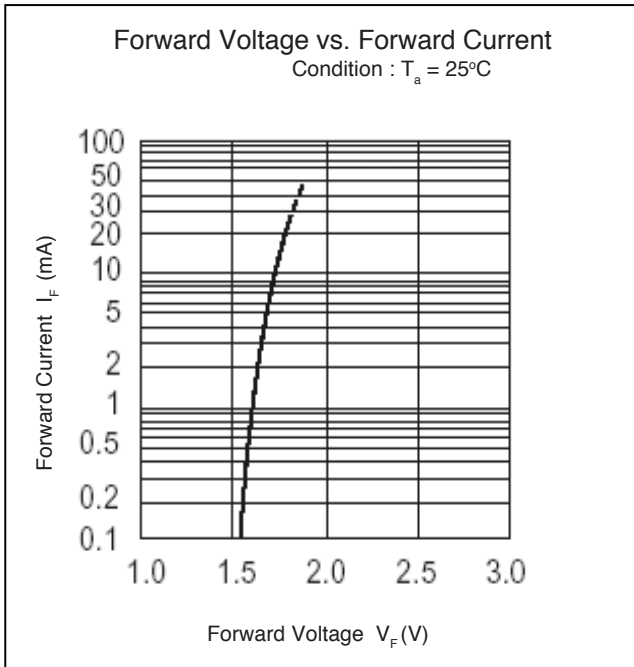
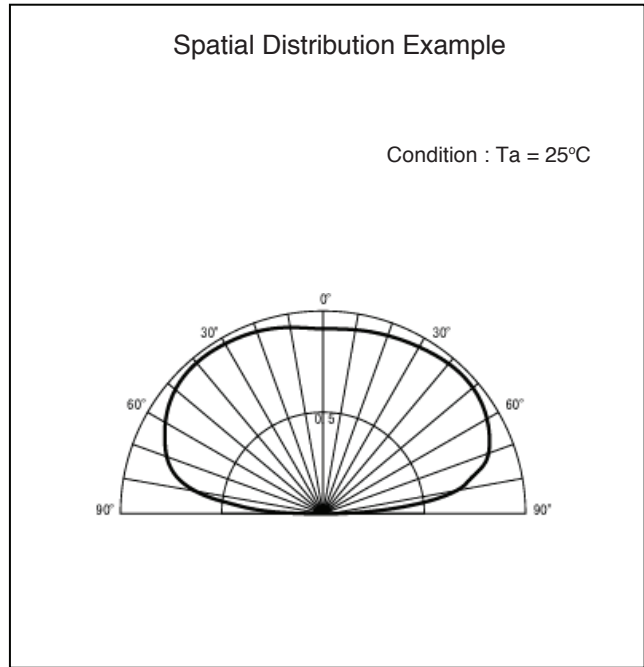
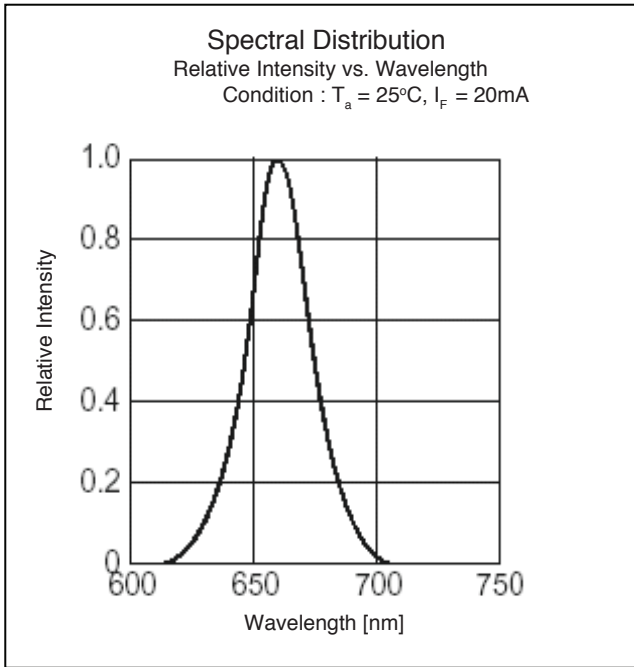

Product Specifications - CMD11504UR (Red)

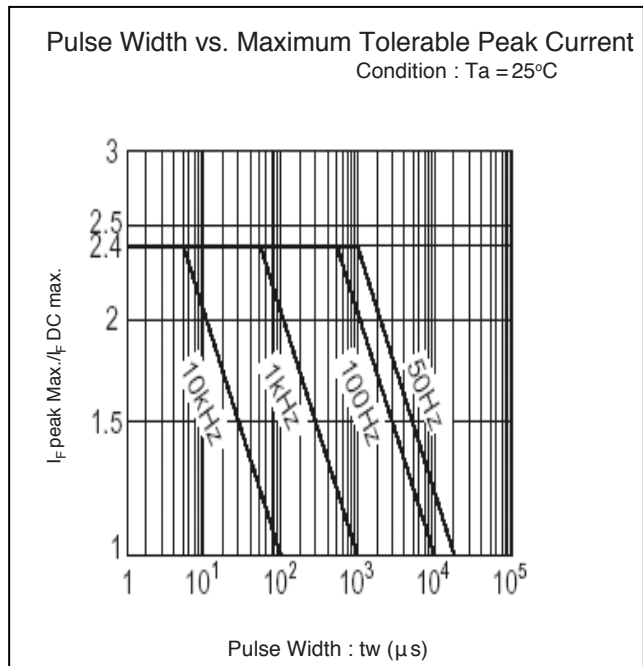
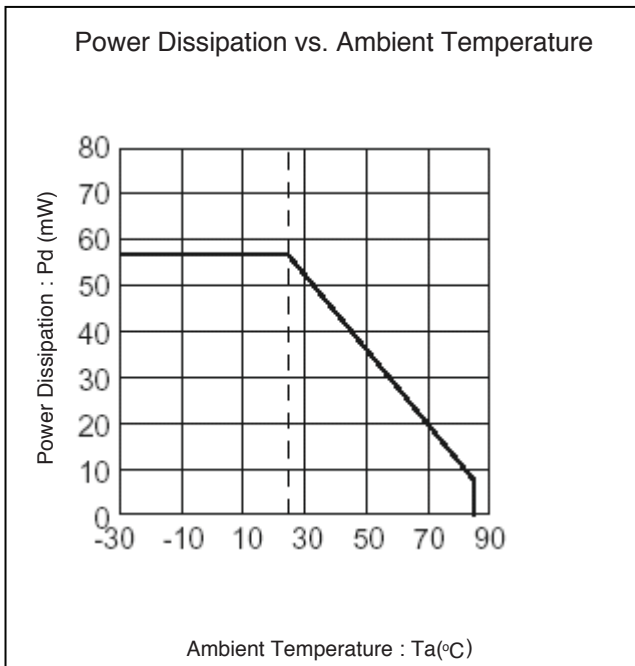
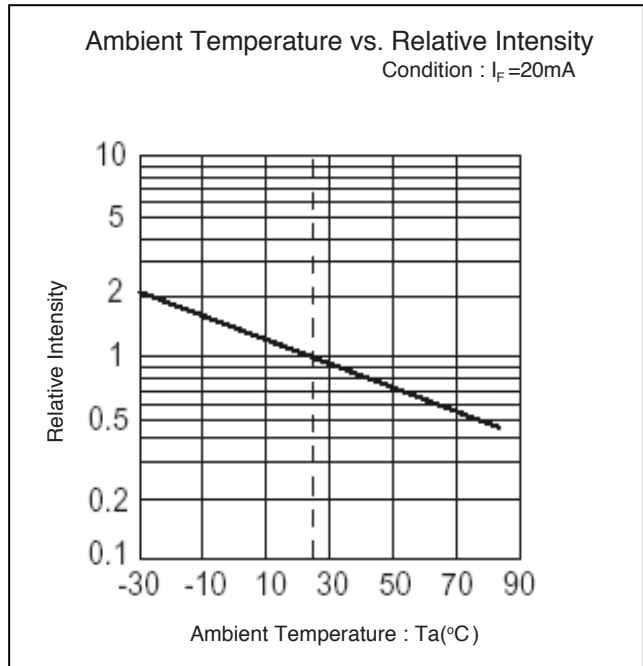
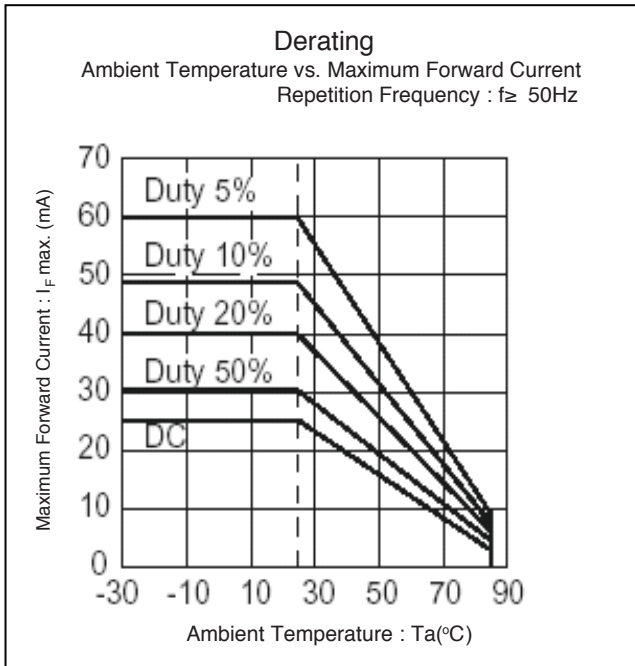

Product Specifications - CMD11504G (Green)

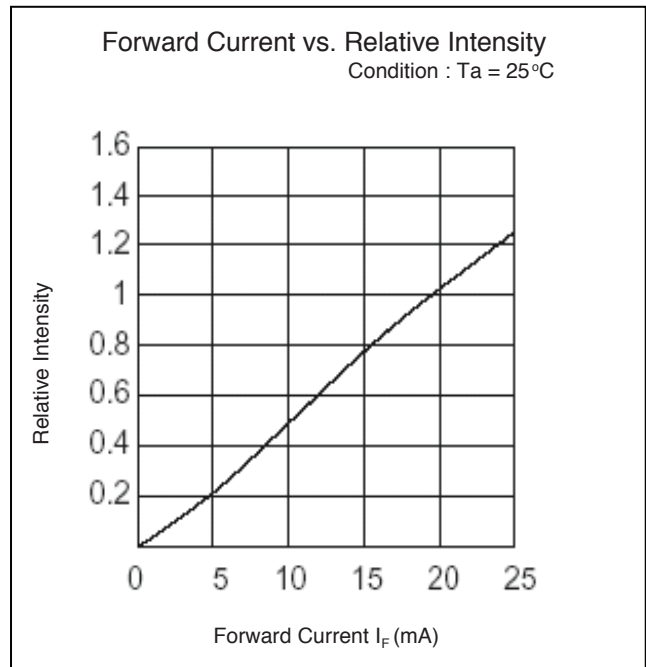
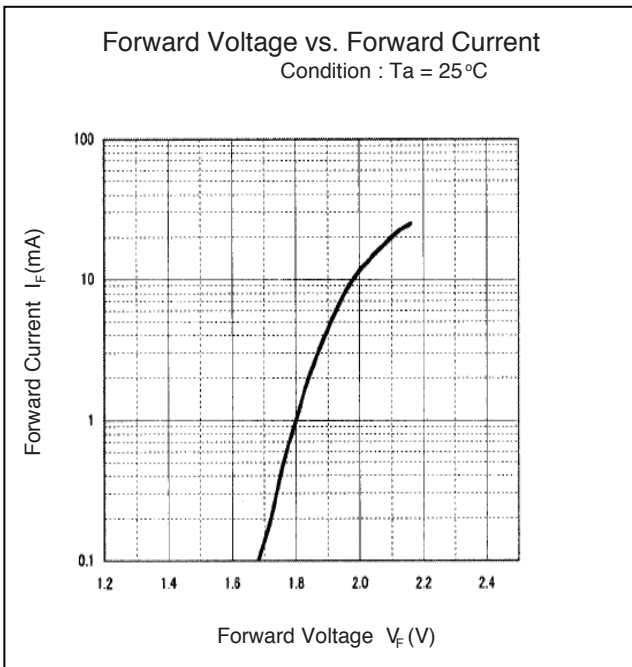
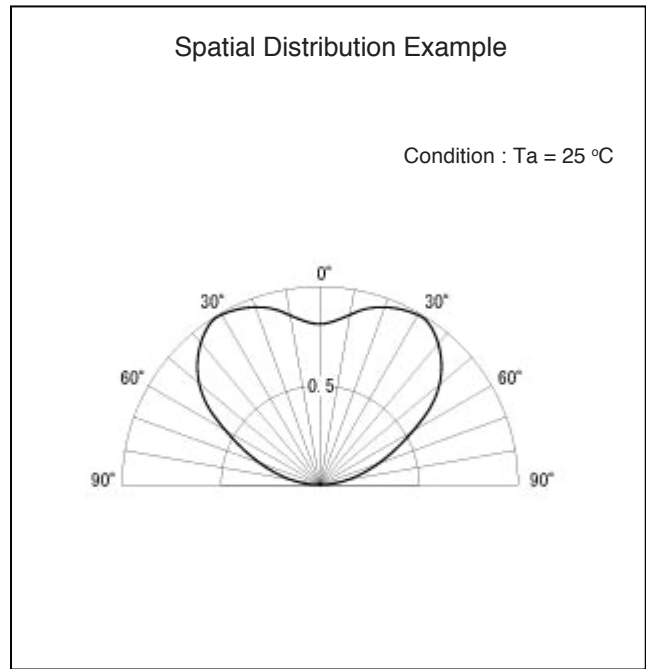
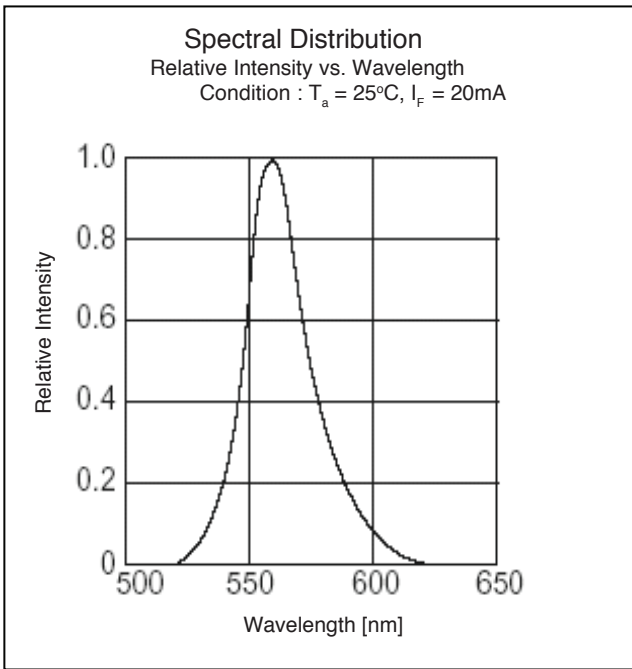

Product Specifications - CMD11504G (Green)

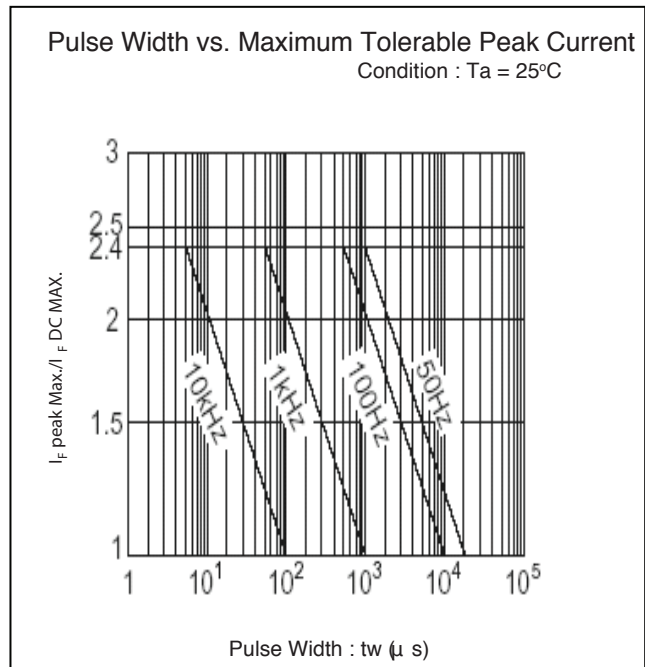
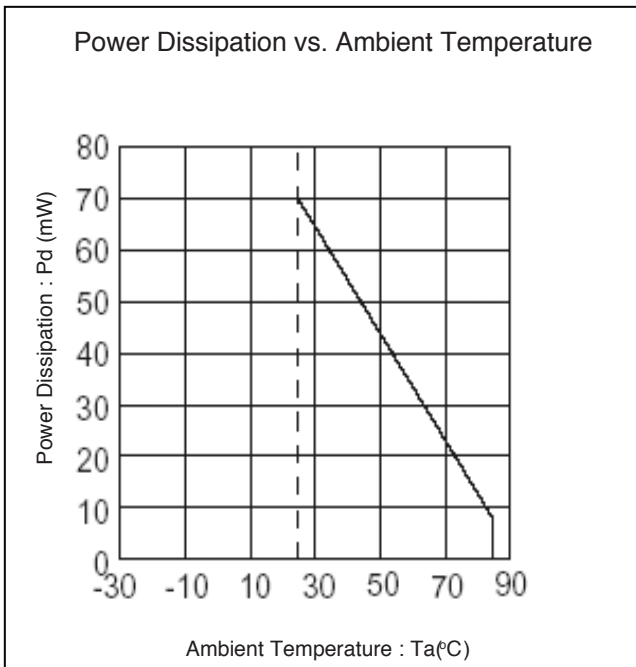
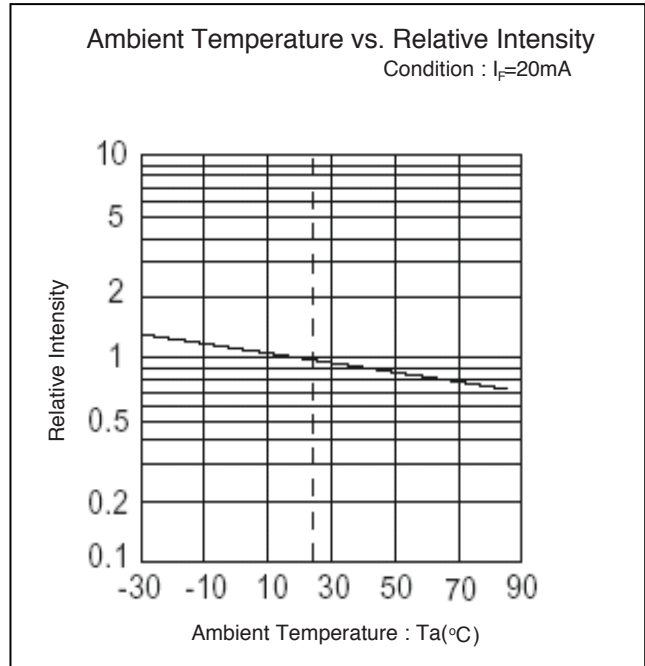
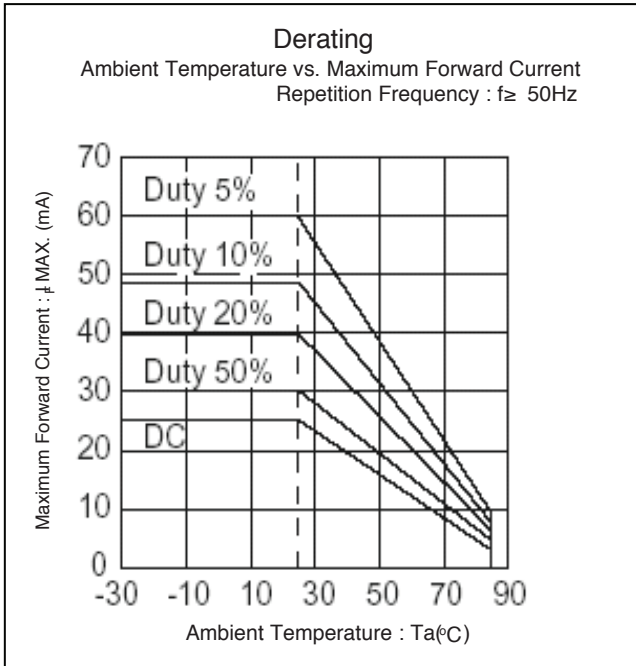

Product Specifications - CMD11504Y (Yellow)

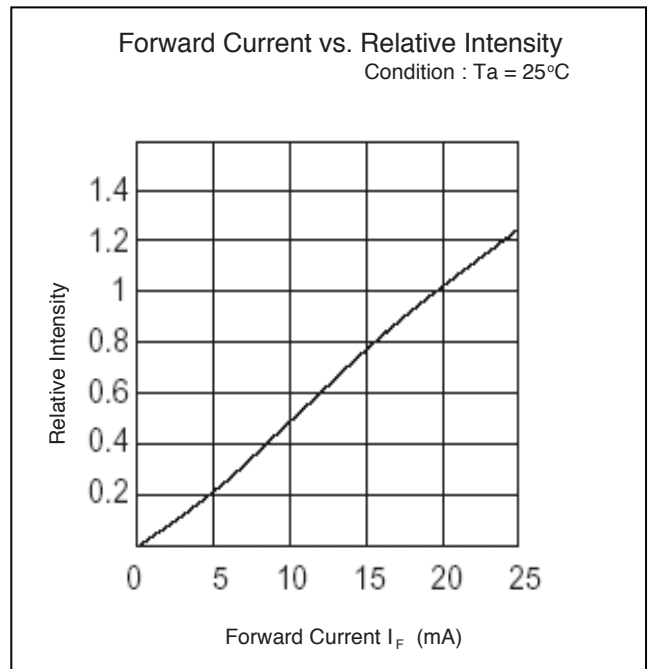
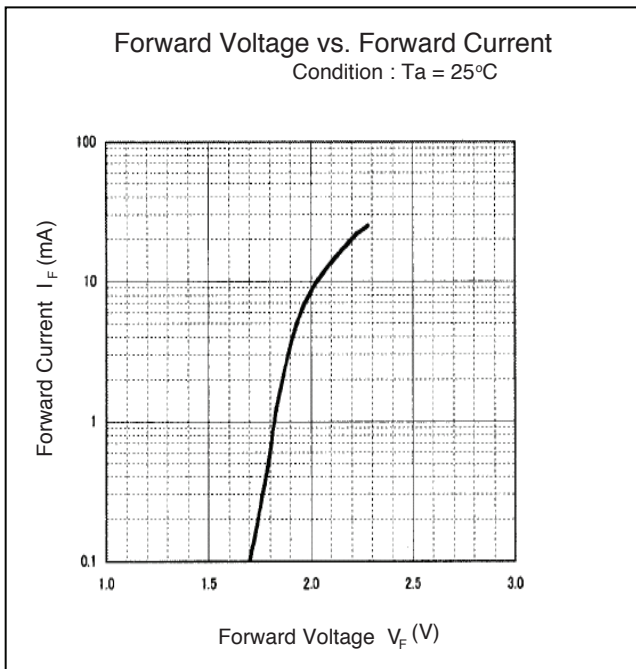
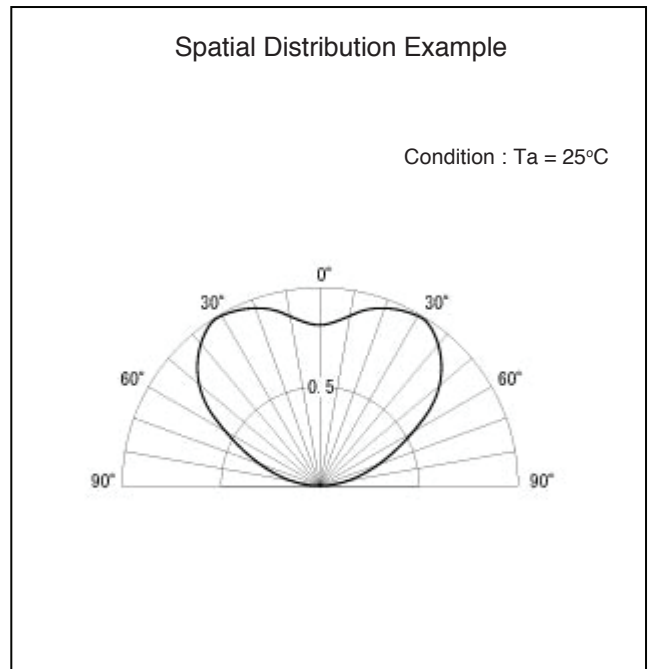
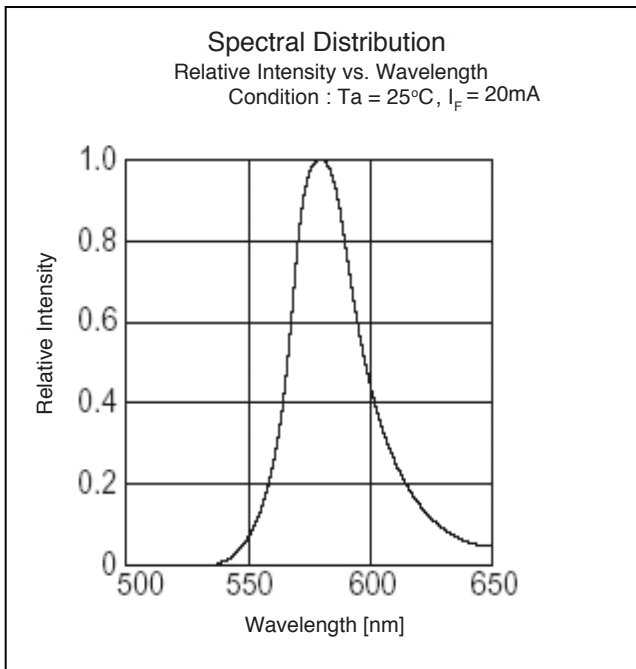

Product Specifications - CMD11504Y (Yellow)

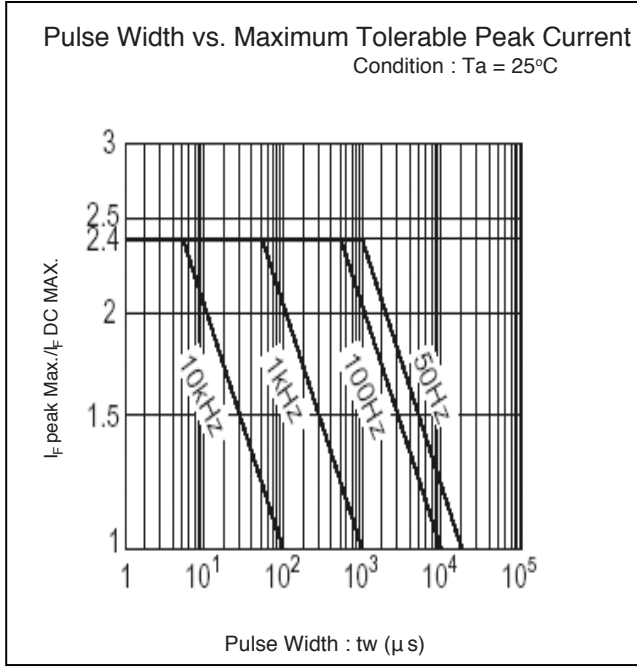
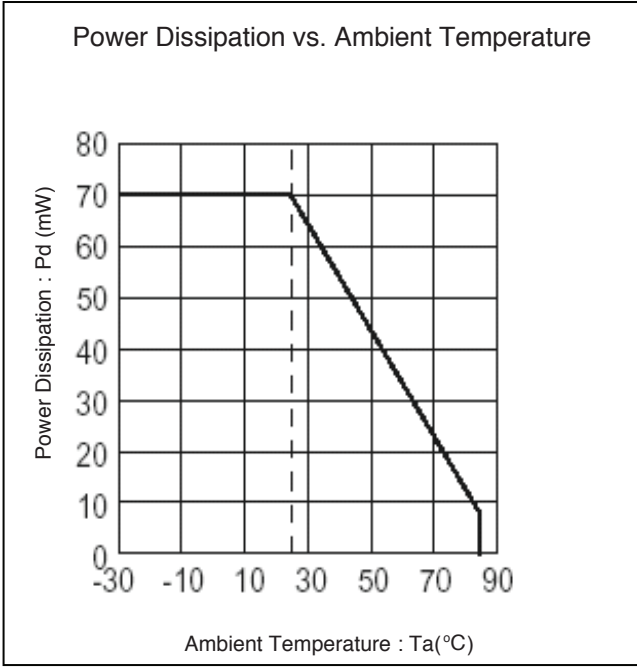
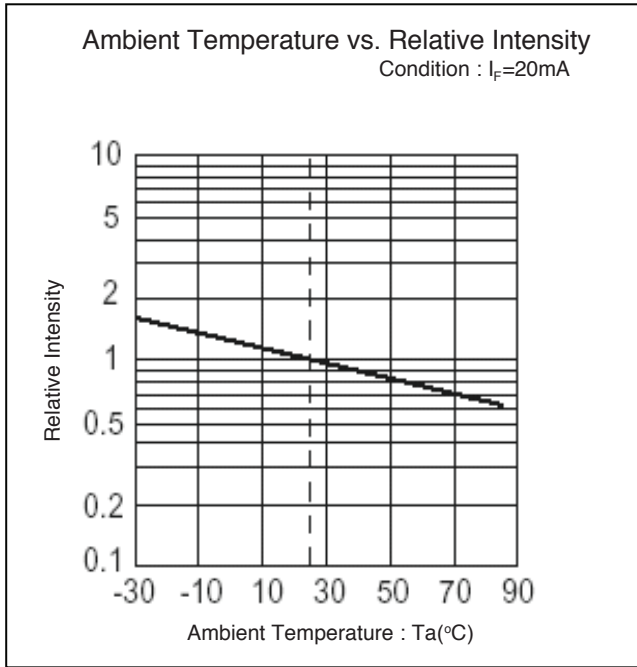
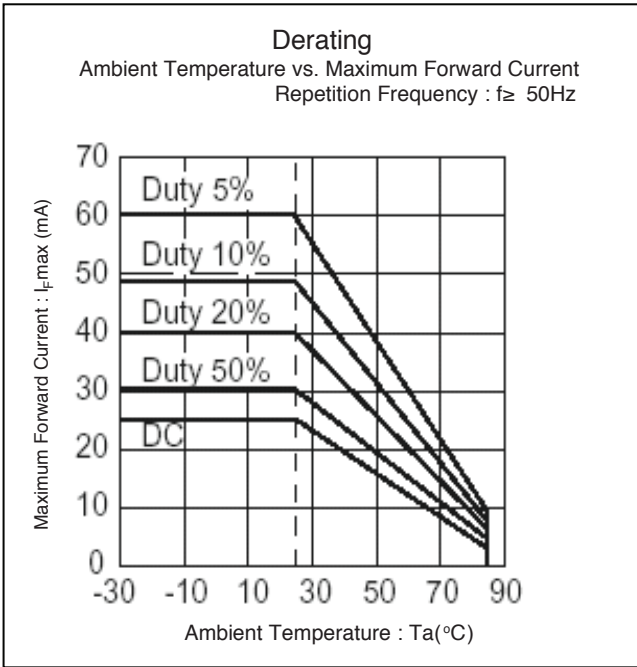

Product Specifications - CMD11504R/G (Red/Green)

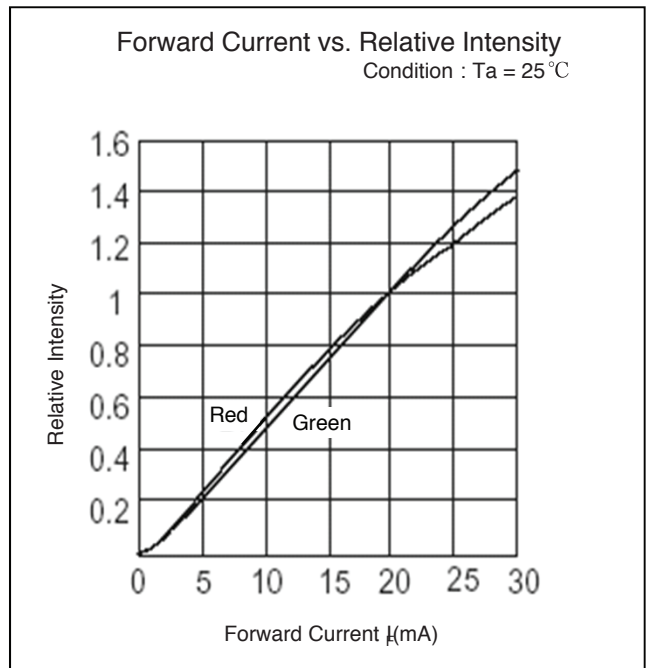
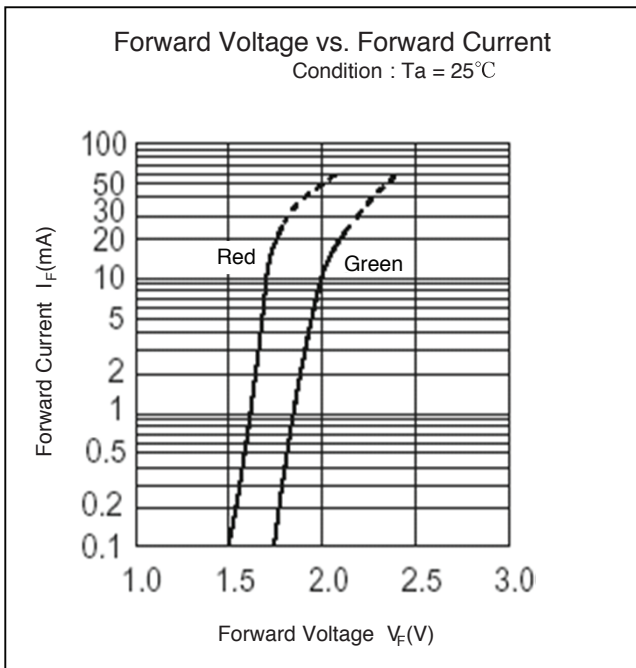
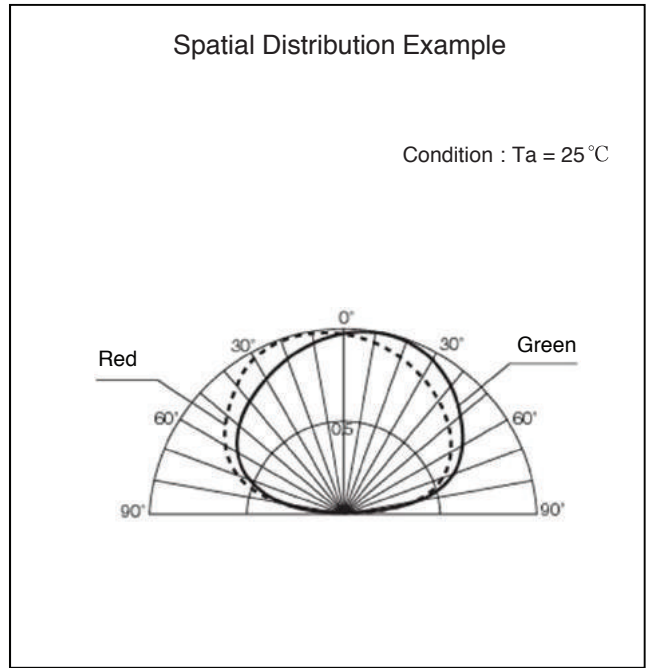
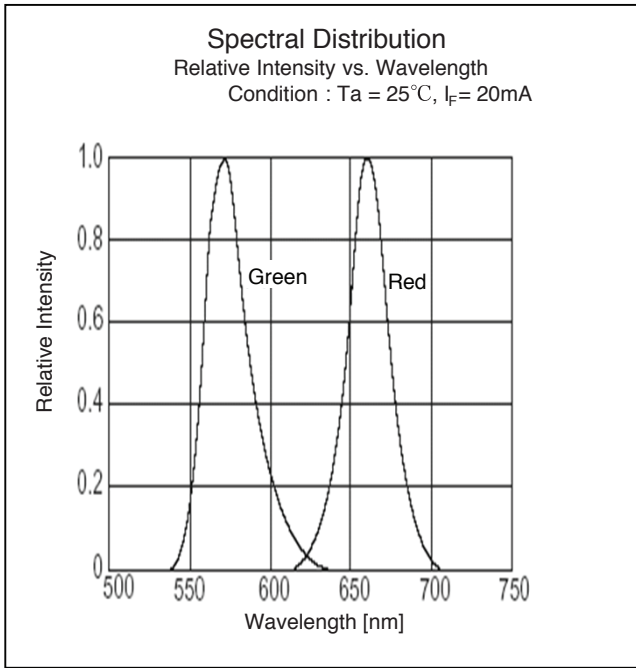

Product Specifications - CMD11504R/G (Red/Green)

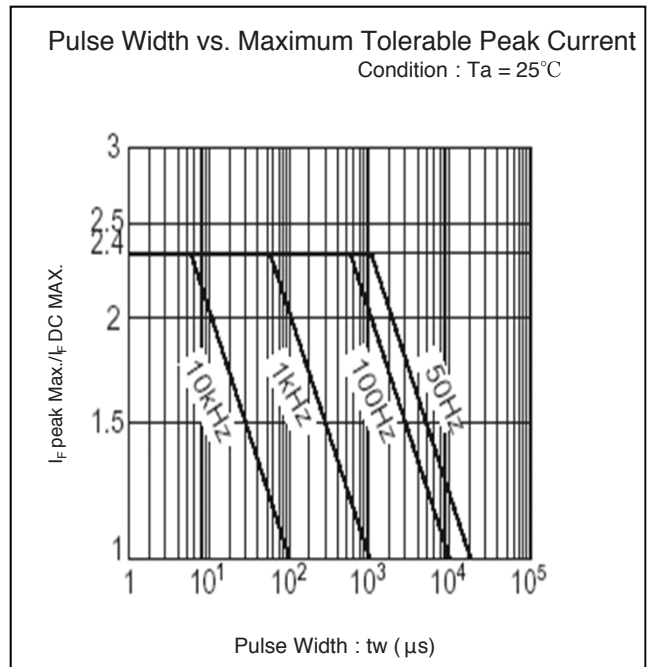
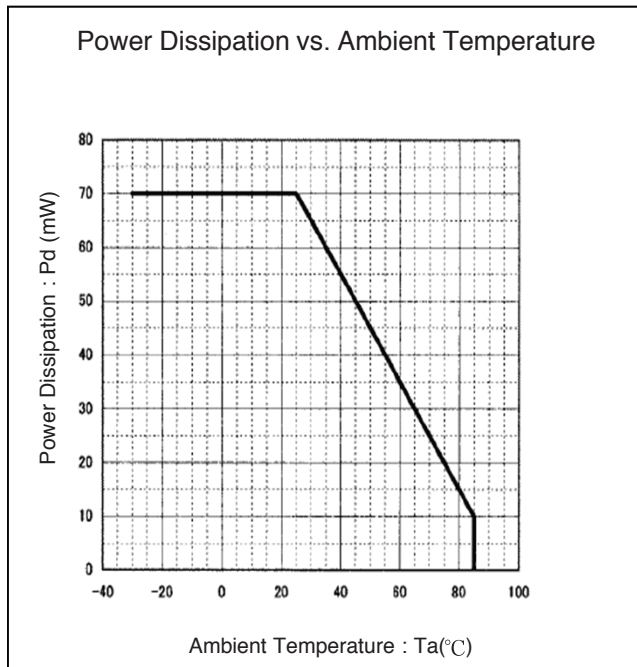
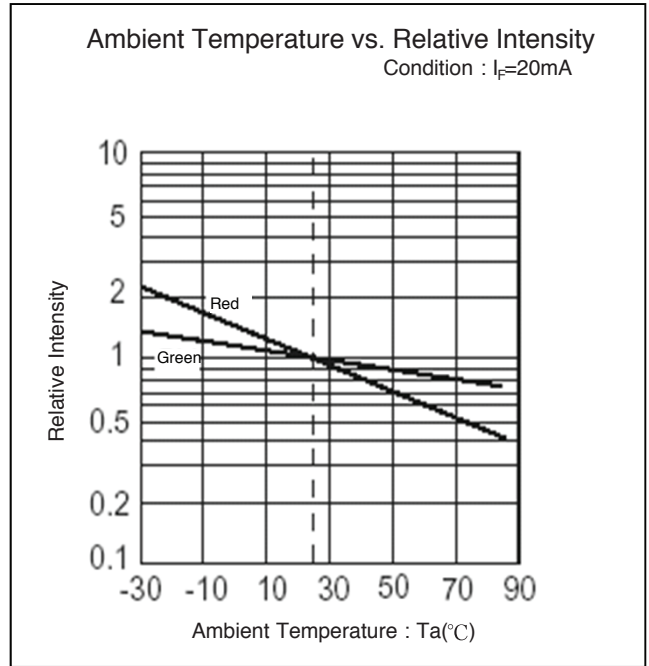
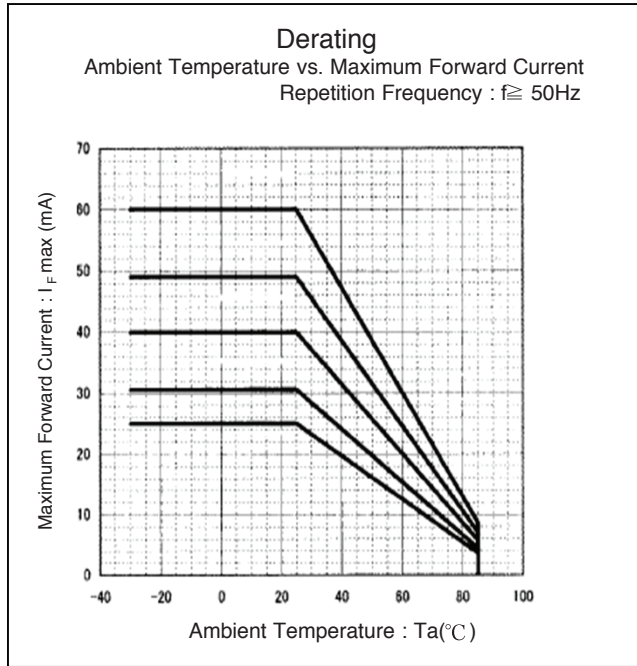

Solder Pad Geometry

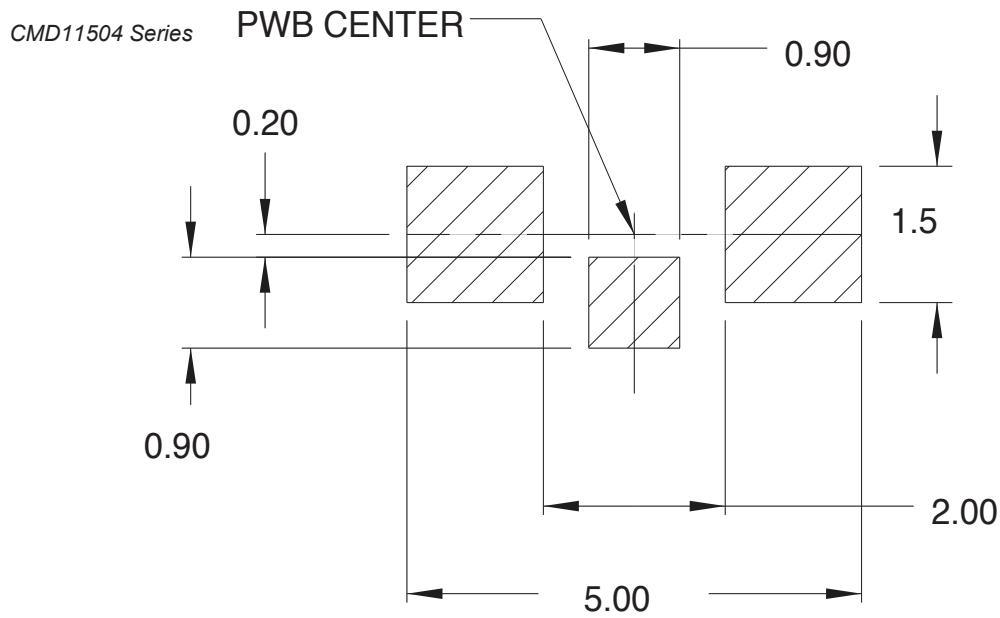

All dimensions in mm.

Compliance and Approvals

