

PC125 Series T-1 PCB Mount LED Circuit Board Indicator

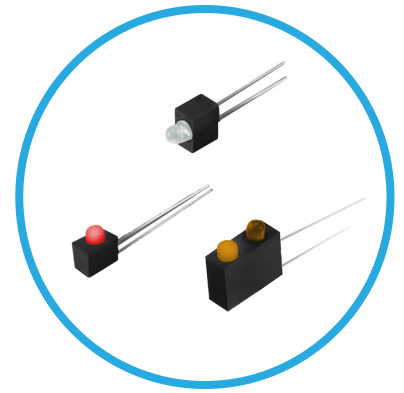

One and two position, right angle and vertical mount, LED circuit board indicator

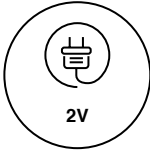

Key Features

- LED size: T-1 (3mm)
- Voltage: 2V
- Terminals: straight leads
- LED single color options: red, amber, and green
- Bi-color option: red/green
- Black plastic mounting block for high contact ratio
- Compliant with RoHS and REACH

Ordering Data

PCT125 (Right Angle Mount)

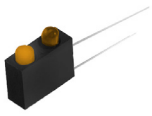

Example:
PCT125-ALP-ALP-R-

Part Number	Color	λ_{pk} (nm)	Iv (mcd)	Viewing Angle	Terminals	Voltage
PCT125-ALP-ALP-R-	Amber/Amber	583	1.6	50	Straight Leads	2V

PCH125 (Right Angle Mount)

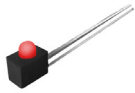

Example:
PCH125-DRG

Part Number	Color	λ_{pk} (nm)	Iv (mcd)	Viewing Angle	Terminals	Voltage
PCH125-200-BCA	Amber	583	30	45	Straight Leads	2V
PCH125-BA	Amber	583	14	60	Straight Leads	2V
PCH125-200-BCG	Green	565	44	45	Straight Leads	2V
PCH125-200-BCR	Red	635	60	45	Straight Leads	2V
PCH125-BR	Red	635	14	60	Straight Leads	2V
PCH125-DRG	Red/Green	635/567	4.3/3.7	118	Straight Leads	2V

PCV125 (Vertical Mount)



Example:
PCV125-DRG

Part Number	Color	λ_{pk} (nm)	Iv (mcd)	Viewing Angle	Terminals	Voltage
PCV125-DRG	Red/Green	635/567	4.3/3.7	118	Straight Leads	2V

Product Dimensions

PCT125 (Right Angle Mount)

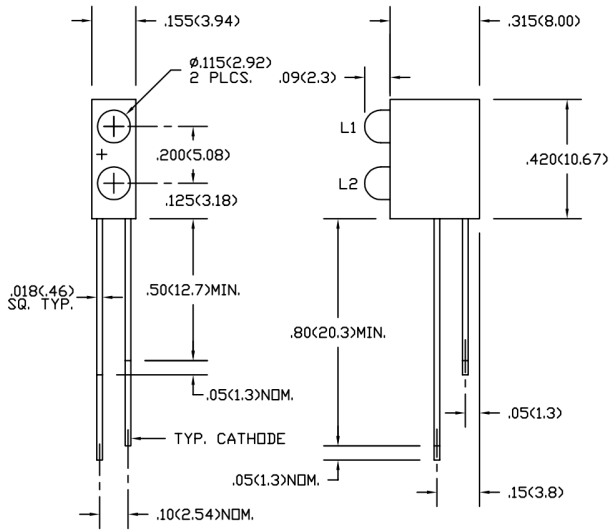

PCH125 (Right Angle Mount)

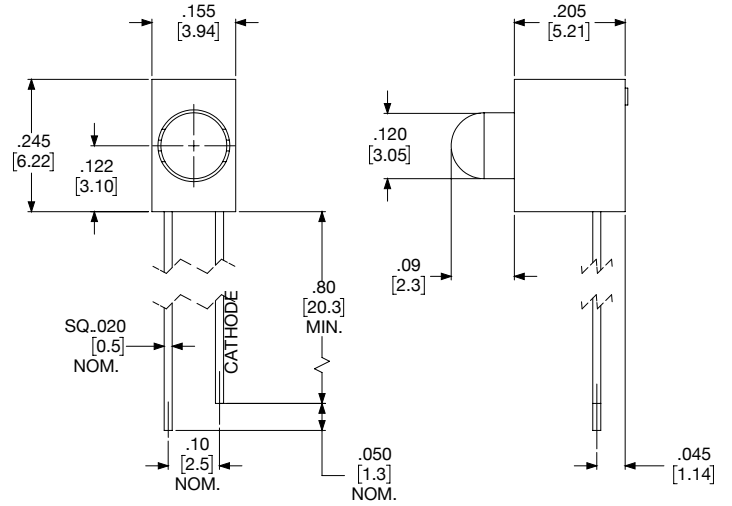

PCV125 (Vertical Mount)

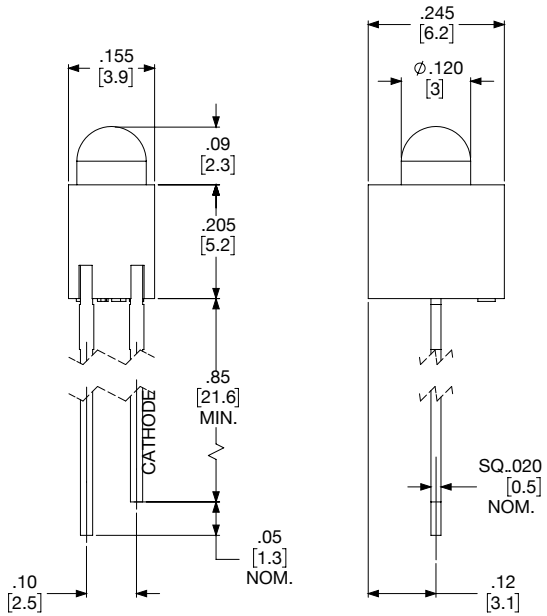

Compliances and Approvals

